

REVISION NOTICE

THESE ARE SUPERSEDING OR SUPPLEMENTARY PAGES TO SAME PUBLICATION OF PREVIOUS DATE

Insert these pages into basic publication
Destroy superseded pages

NAVWEPS 01-40ATB-1

Flight Manual

NAVY MODEL
A3D-2P
AIRCRAFT

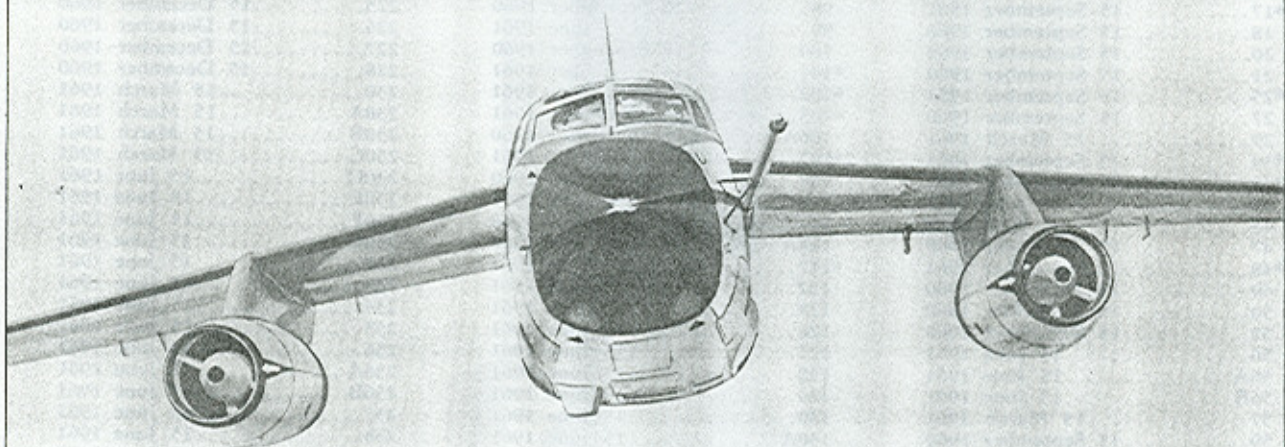

PUBLISHED BY DIRECTION OF THE CHIEF OF THE BUREAU OF NAVAL WEAPONS

P-20135-X

15 June 1960
Revised 15 September 1961

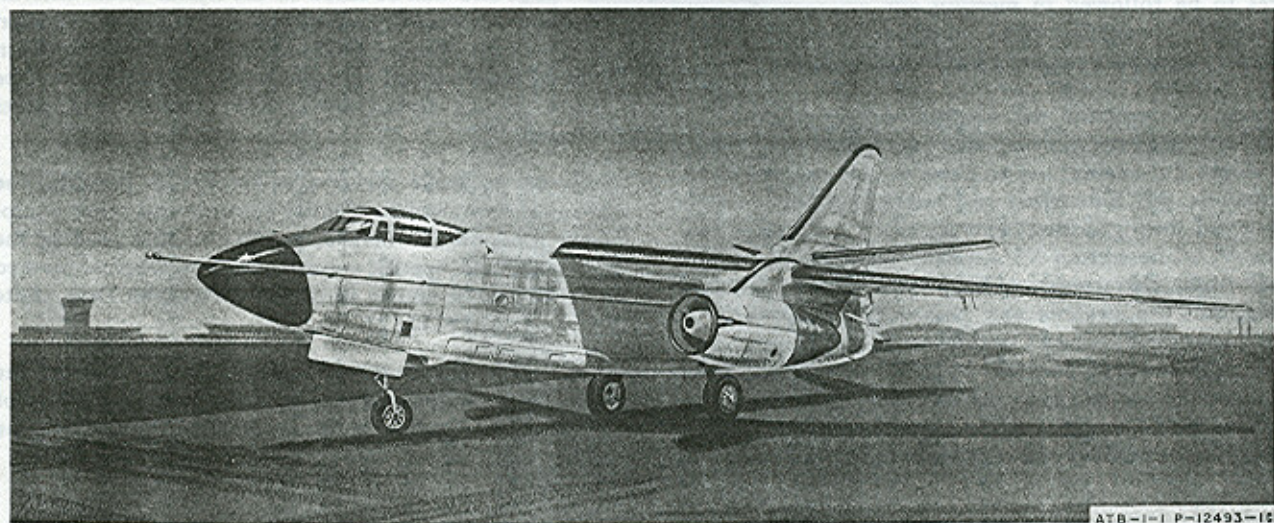
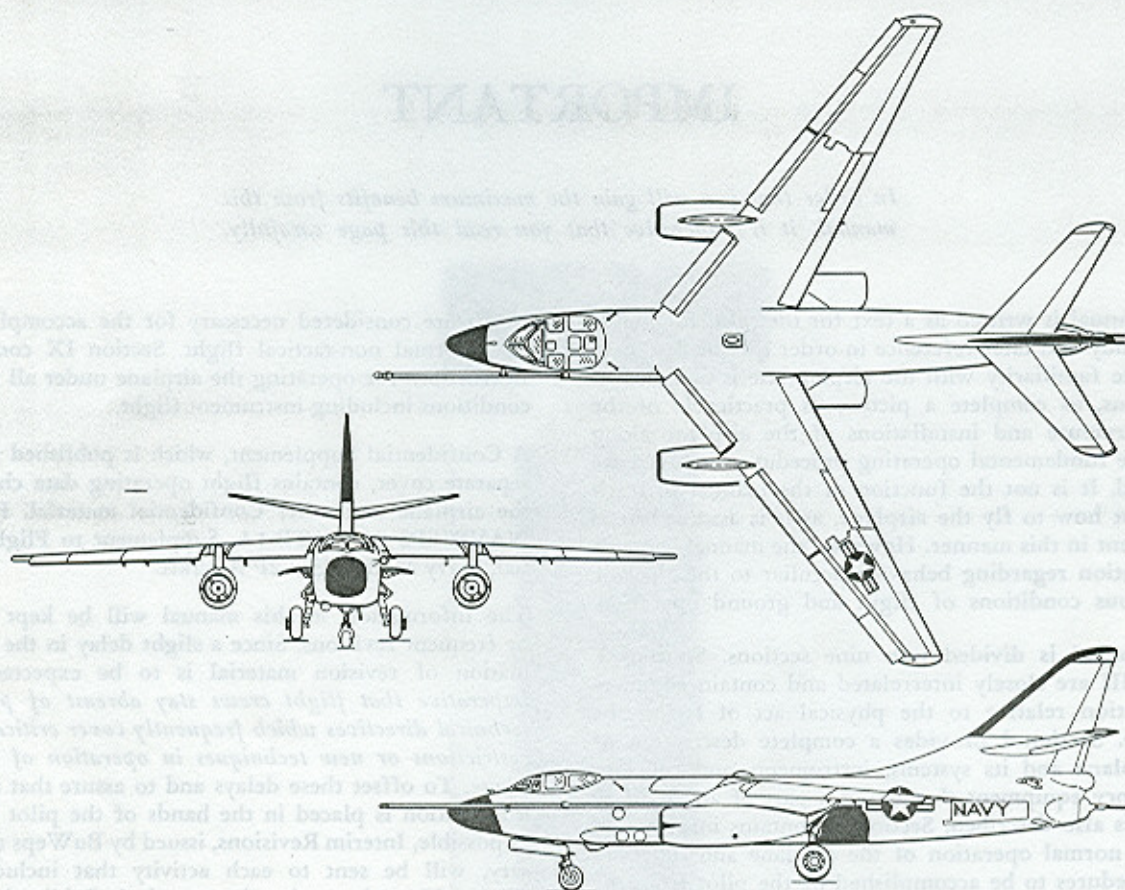

ATB-1-1 P-12493-10

Figure 1-1. Model A3D-2P Airplane

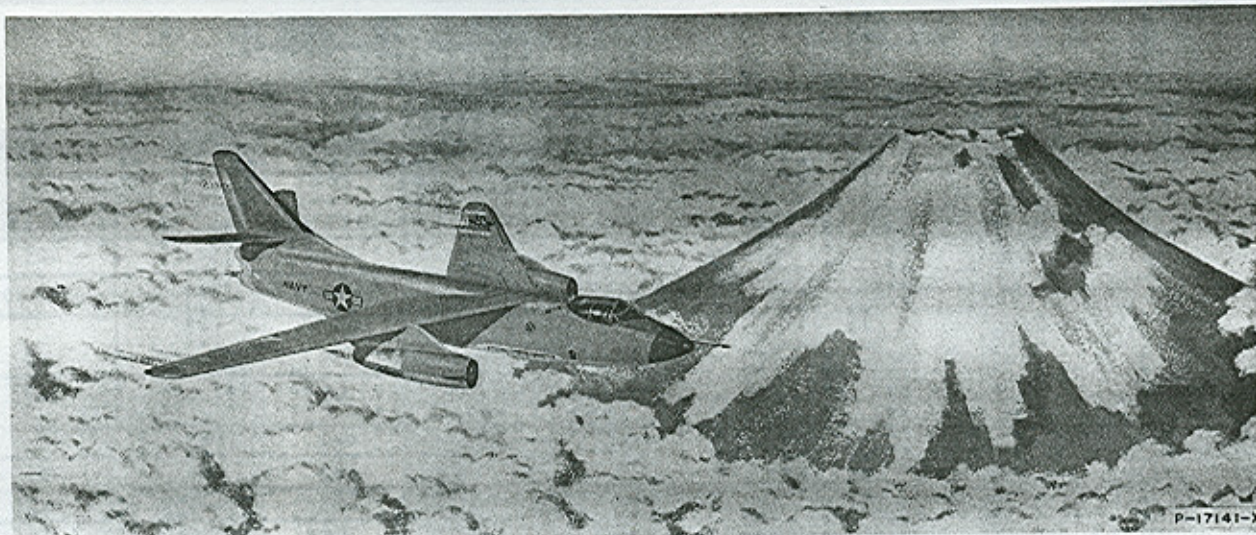

SECTION I

DESCRIPTION

THE AIRPLANE

Navy Model A3D-2P is a three-place, carrier based, long range, high performance, day and night photographic-reconnaissance airplane. It is powered by two Pratt and Whitney J57-P-10 series turbojet engines installed in under-wing nacelles, and is equipped with retractable tricycle landing gear with a steerable nose wheel. The airplane is operable from carriers which are equipped with C-7 and C-11 steam catapults and Mark 7 arresting gear. It is also designed for field JATO installations, using a maximum of twelve 4500-pound thrust bottles.

MAIN DIFFERENCES

The A3D-2P airplane differs from the A3D-2 in that it has:

1. A camera compartment.
2. A flash bomb bay in the fuselage between the camera compartment and the forward fuel tank.
3. A greater gross weight.
4. A simpler fuel transfer system.
5. A different horizontal stabilizer range.
6. A higher cockpit pressure differential.
7. A drop-out generator, but no storage battery.
8. No bomb bay spoiler.
7. Its ATM's in a different location.

Revised 15 September 1960

AIRPLANE DIMENSIONS

Wing span (wings spread)	72' 6"
Wing span (wings folded)	49' 2 $\frac{3}{8}$ "
Wing maximum height during folding	27' 3 $\frac{3}{4}$ "
Wing height folded	16' 7 $\frac{1}{8}$ "
Length (fin erect)	74' 4 $\frac{1}{8}$ "
Height (fin erect)	22' 9 $\frac{3}{4}$ "
Height (fin folded)	16' 8"

See figure 2-4 for minimum turning radius and ground clearances.

CREW

The airplane is designed to seat a three-man crew consisting of a pilot, a photo-navigator, and a photo technician-gunner.

GENERAL ARRANGEMENT

For general arrangement of the airplane, including location of the various compartments, water containers, external power receptacles, escape hatch, fuel tanks etc., see figure 1-3. Of the compartments, only the camera compartment and cockpit are pressurized and accessible in flight.

ENGINE

The Pratt and Whitney J57-P-10 Turbo-Wasp engine is a continuous flow gas turbine engine consisting of two multi-stage, axial flow compressors, eight combustion

A3D MAIN DIFFERENCES TABLE

	A3D-1	A3D-2			A3D-2 VERSIONS		
	BOMBER	BOMBER	TANKER	DECM	PHOTO	ECM	TRAINER
WING BASIC CAMBERED	YES	YES	NO	NO	28 A/P	13 A/P	NO
	NO	NO	YES	YES	2 A/P	12 A/P	YES
ENGINES	J57-P-6B	J57-P-10	J57-P-10	J57-P-10	J57-P-10	J57-P-10	J57-P-10
FUSELAGE FUELING PROBE FUELING DROGUE TOTAL FUEL CAMERA WINDOWS CAMERA FAIRING WINDOWS & DOOR LOWER RADOME BOMB BAY SPOILER	NO	YES	YES	YES	YES	YES	YES
	NO	NO	YES	CONVERTIBLE	NO	NO	NO
	4530	4530	6540	5280	4466	4466	4980
	NO	NO	NO	NO	YES	NO	NO
	NO	NO	NO	NO	YES	NO	NO
	NO	NO	NO	NO	NO	YES	YES
	NO	NO	NO	NO	NO	YES	NO
	YES	YES	YES	YES	SMALL FLASH BOMBS	NO	NO
YES	YES	YES	YES	NO	NO	NO	
HORIZONTAL STABILIZER TRAVEL 6° ANU 4° AND 10½° ANU 3° AND	YES	YES 116 A/P	NO	NO	NO	NO	NO
	NO	YES 7 A/P	YES	YES	YES	YES	YES
FIN TIP RADOME	NO	NO	NO	NO	NO	YES	NO
TAIL TURRET AERO-21B	YES	YES	YES	NO	YES	YES	NO
DECM	NO	NO 98 A/P YES 25 A/P	NO	YES	NO	1 A/P	NO
ASB GEAR	ASB-1A	ASB-1A	ASB-1A	ASB-7	ASB-1B	ASB-1B	ASB-1A
FUEL TRANSFER	AIR PRESSURE	ELECTRIC PUMP	ELECTRIC PUMP	ELECTRIC PUMP	ELECTRIC PUMP	ELECTRIC PUMP	ELECTRIC PUMP
DROP OUT GENERATOR	NO	NO	NO	NO	YES	YES	YES
BATTERY	YES	YES	YES	YES	NO	NO	NO
INTERIOR SEATS 4TH CREWMAN PROVISIONS PERISCOPE	3	3	3	3	3	7	8
	YES	YES	YES	YES	NO	NOT APPLICABLE	NOT APPLICABLE
	YES	YES	YES	YES	NO	NO	YES
ESCAPE BAIL OUT DITCHING	CHUTE	CHUTE	CHUTE	CHUTE	CHUTE	CHUTE & SIDE DOOR	CHUTE & SIDE DOOR
	SLIDING HATCH	SLIDING HATCH	SLIDING HATCH	SLIDING HATCH	1 HINGED HATCH	2 HINGED HATCHES	2 HINGED HATCHES

Figure 1-2. Main Difference Table

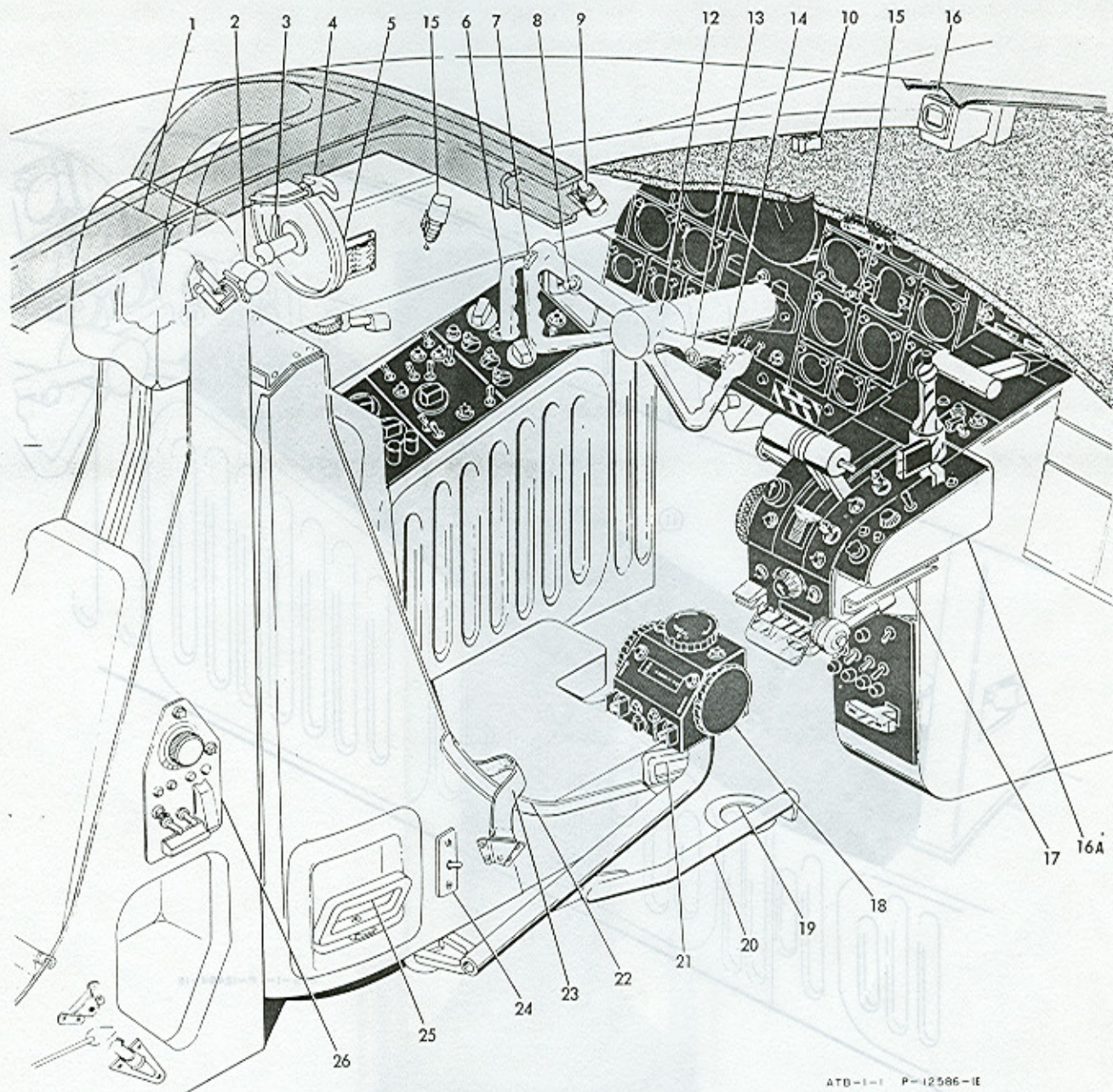

1. Gunner's seat
2. Side oblique sight
3. Headrest lock
4. Bailout warning horn handle
5. Pilot's headrest
6. Nose wheel steering control
7. Horizontal stabilizer a-c control switch
8. Autopilot release switch
9. Autopilot floodlight
10. Pilot's approach index
11. Deleted
12. Control column
13. Extra picture switch
14. Radio-ICS switch

15. Instrument panel floodlight
16. Standby compass
- 16A. Skid-turn control
17. Chartboard support
18. Autopilot control (extended position)
19. Handpump hydraulic gage
20. Brake system hydraulic handpump handle (operating position)
21. Harness release handle
22. Pilot seat
23. Seat belt
24. Seat adjust switch
25. Emer lower escape handle
26. Gunners seat bomb release panel

General Arrangement
Figure 1-4. Pilots Station (Sheet 2)

Revised 15 March 1961

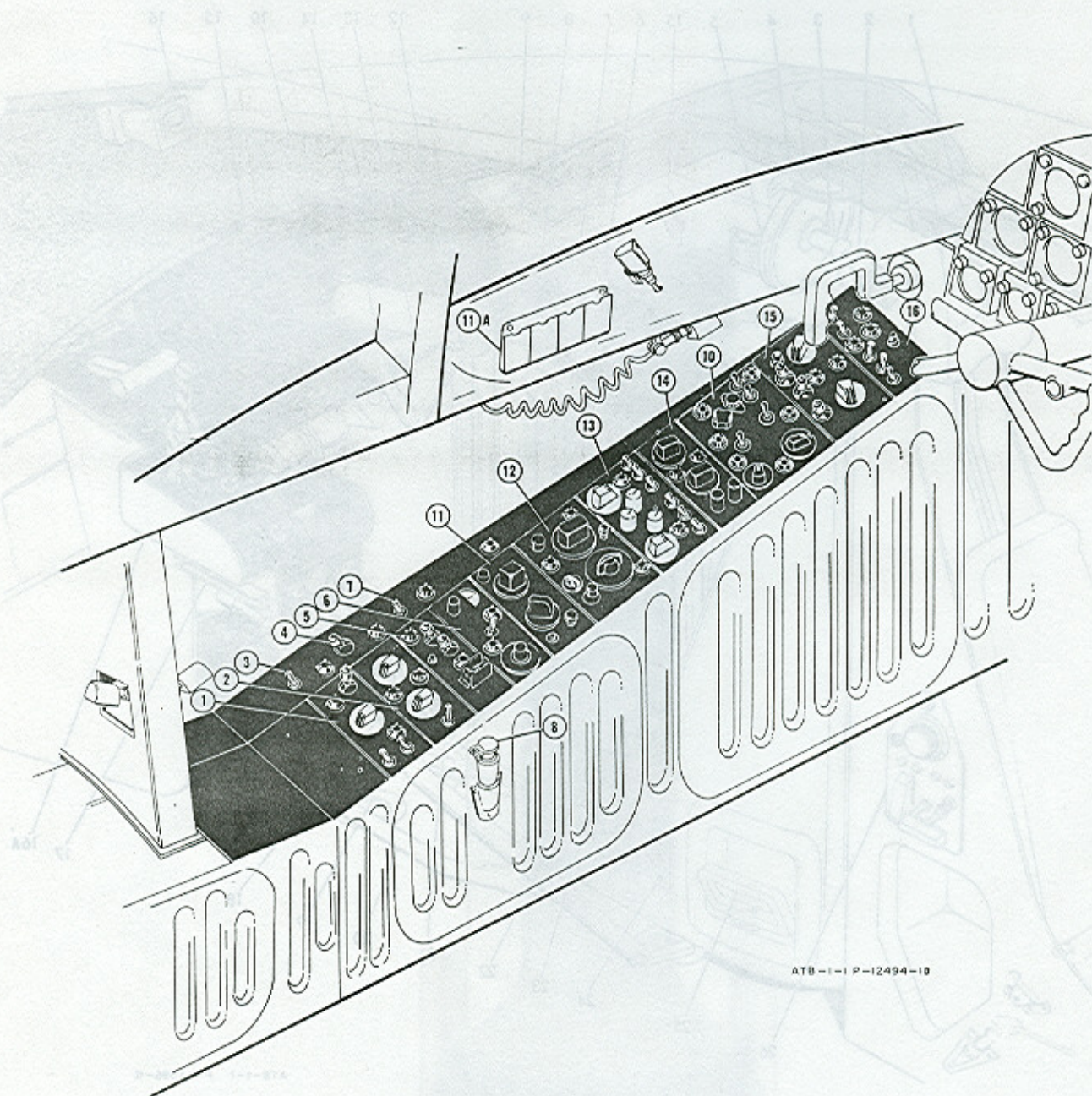

ATB-1-1 P-12494-10

1. Air-conditioning and pressure control
2. Interior lights control panel
3. UHF-VHF selector switch
4. Oxygen control
5. ATM and AFCS control panel
6. MA-1 compass controller
7. Navigation select switch (TACAN-VOR)
8. Pilot's oxygen outlet

9. Deleted
10. Viewfinder control panel
11. ARC-1 radio control panel
- 11A. Card holder
12. ARC-27A radio control panel
13. Interphone control panel
14. ARR-40 radio control panel
15. Fuel system control panel
16. Exterior lights control panel

Left-Hand Console

Figure 1-4. Pilots Station (Sheet 3)

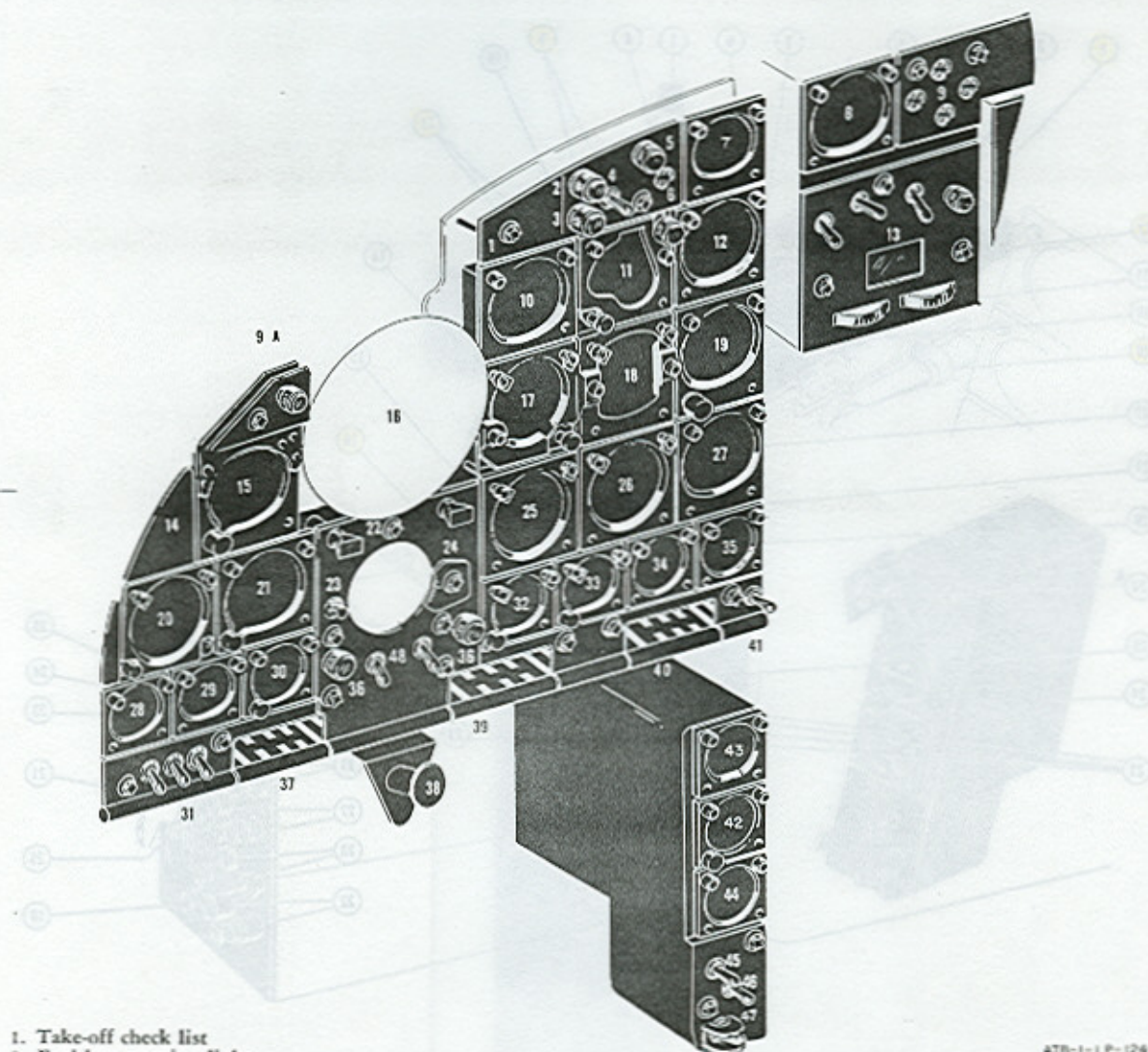

1. Take-off check list
2. Fuel low warning light
3. Master generator warning light
4. Windshield wiper switch
5. Flight controls hyd. press. warning light
6. Utility hyd. press. warning indicator
7. Flaps position indicator
8. Trim position indicator
9. Wheel position indicators
- 9A. Tri-Met camera indicating light
10. ID-250/ARN indicator
11. ID-249/ARN course indicator
12. ID-310/ARN range indicator
13. Master camera control
14. Landing check list
15. Airspeed and Mach indicator
16. Viewfinder
17. Vertical gyro attitude indicator
18. Turn and slip indicator
19. Rate of climb indicator
20. ID-257/APN height indicator
21. Altimeter
22. Engine fire warning lights
23. Fire warning lights test switch
24. Aileron trim position indicator
25. Left engine performance indicator
26. Right engine performance indicator

27. Fuel quantity indicator
28. Cockpit pressure altimeter
29. Oxygen quantity indicator
30. Accelerometer
31. Camera operate switches
32. Left engine press. ratio indicator
33. Right engine press. ratio indicator
34. Left engine fuel flow indicator
35. Right engine fuel flow indicator
36. L and R ATM compart. overtemp. warn. lights
37. Aileron power boost release handle
38. Rudder pedal adjust knob
39. Rud. and elev. boost release handle
40. Emergency air brake handle
41. Anti-skid switch
42. Angle of attack indicator
43. Free air temperature indicator
44. ATM compart. temp. indicator
45. ATM compart. temp. indicator selector switch
46. ATM compart. overtemp. warning lights test switch
47. ATM over-pressure test switch
48. ATM bleed air shutoff switches

ATB-1-1 P-12495-18

Instrument Panel

Figure 1-4. Pilots Station (Sheet 4)

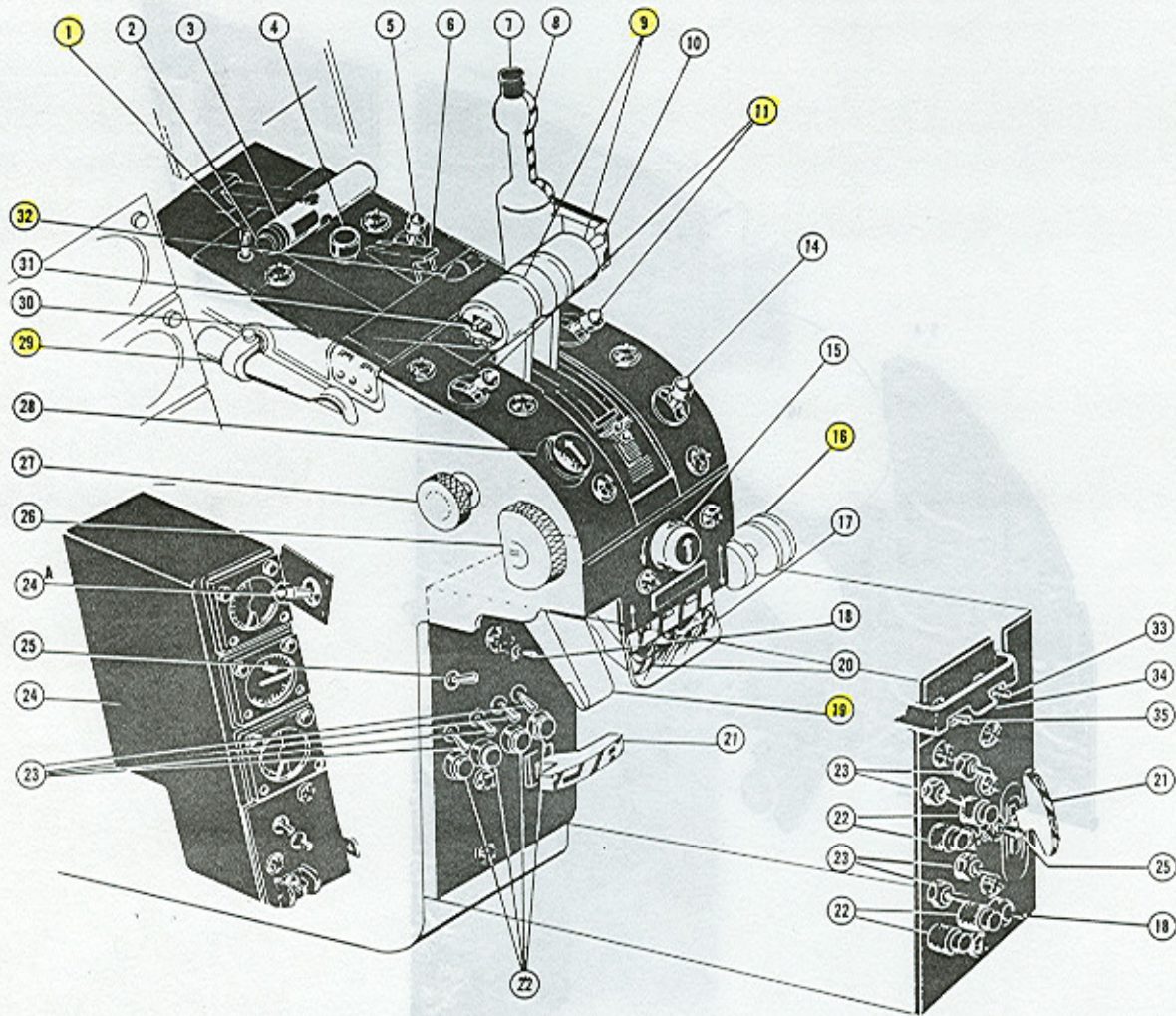

- | | |
|------------------------------------|--|
| 1. Engine starter switch | 20. Emergency flap control |
| 2. Jato firing switch | 21. Emergency generator handle |
| 3. Catapult handgrip | 22. Generator warning lights |
| 4. Jato armed warning light | 23. Generator switches |
| 5. Jato jettison switch | 24. Pilots auxiliary instrument panel |
| 6. Jato arming switch | 24A. Horiz stab. d.c. trim power supply ⁽¹⁾ |
| 7. Gust lock handle release button | 25. Bus tie switch |
| 8. Gust and wing pin lock control | 26. Horizontal stabilizer trim control |
| 9. Throttles | 27. Throttle friction control |
| 10. Exterior lights master switch | 28. Rudder trim control switch |
| 11. Master engine switches | 29. Arresting hook control |
| 12. Deleted | 30. Speed brake switch |
| 13. Deleted | 31. Throttle radio-ICS switch |
| 14. Drag chute switch | 32. Wing fold handle |
| 15. Aileron trim control switch | 33. Horizontal stabilizer d-c trim emergency off switch ⁽²⁾ |
| 16. Landing gear control | 34. Horizontal stabilizer actuator gang bar ⁽²⁾ |
| 17. Emergency landing gear control | 35. Horizontal stabilizer a-c trim emergency off switch ⁽²⁾ |
| 18. External power switch | |
| 19. Flap control | |

⁽¹⁾ Airplanes BuNo. 142668-142669, 144825-144836

⁽²⁾ Airplanes BuNo. 144837 and subsequent.

Center Console

Figure 1-4. Pilots Station (Sheet 5)

- e. energizes wing air valve, thus effecting emergency alternate wing fuel transfer by means of wing tank pressurization.
5. OFF
- a. opens wing vent valve.
 - b. closes wing air valve.
 - c. de-energizes wing fuel transfer pumps thus discontinuing all wing tank fuel transfer.
 - d. energizes wing pilot float valve, which closes the wing pressure fueling shutoff valves. This prevents reverse transfer from the forward tank to the wing tanks during dives.

- 6. IFR. (Refer to SINGLE POINT FUELING in Section IV.)

CAUTION

- Place the transfer switch at OFF when wing tanks fuel transfer has been completed. Do not operate the wing fuel transfer pumps over 30 minutes with the wing tanks empty and the pumps not submerged in fuel.
- When transferring wing fuel either by the EMER WINGS or EMER WINGS ALT sys-

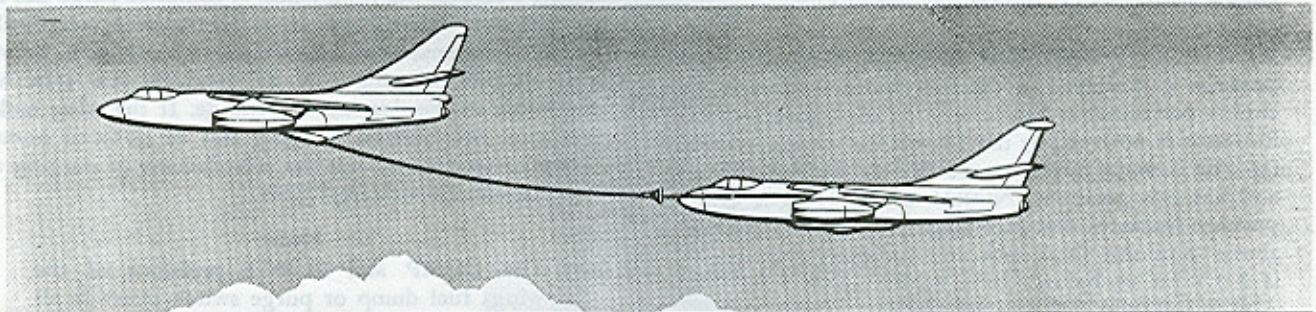

FUEL QUANTITY DATA US GALLONS

TANKS		USABLE FUEL	UNUSABLE FUEL	EXPANSION SPACE	TOTAL VOLUME
AFT FUSELAGE	P	1300.0*	3.0	625.0**	1928.0
	G				
FWD FUSELAGE	P	1814.0	3.0	18.0	1835.0
	G	1832.0	3.0	0.0	
LEFT WING	P	649.0	1.0	18.0	668.0
	G	667.0	1.0	0.0	
RIGHT WING	P	649.0	1.0	18.0	668.0
	G	667.0	1.0	0.0	

P-PRESSURE FUELING

G-GRAVITY FUELING

*AFT FUSELAGE TANK LIMITED TO THIS QUANTITY BY FLOAT SWITCH TO MAINTAIN AIRPLANE TAKE-OFF C.G. WITHIN AFT C.G. LIMIT.

**USED FOR EXPANSION SPACE ONLY TO LIMIT C.G. TRAVEL.

DATA AS OF: 10 JUNE 1959

DATA BASIS: CALCULATIONS BASED ON NEWLY INSTALLED TANKS. CAPACITY INCREASES WITH SERVICE.

FUEL: JP-4

USABLE FUEL LOADS	P	G
FWD AND AFT FUSELAGE TANKS	3114.0	3132.0
FWD AND AFT FUSELAGE TANKS AND WING TANKS	4412.0	4466.0

PS-12581-1 E

Figure 1-5. Fuel Quantity Data Table

tems, be sure the gravity transfer switch is at NORMAL to insure complete isolation of the forward fuselage tank.

FUEL BOOST PUMPS

Two electrically driven fuel boost pumps powered by the 115/200-volt left hand a-c generator bus are mounted in the bottom of the aft fuselage fuel tank. The boost pumps supply fuel under pressure at 12-30 psi to the engine fuel pump mounted on each engine. The fuel system is interconnected by a fuel crossfeed valve, making possible the operation of both engines from either boost pump. Each boost pump line has a shutoff valve located downstream of the pump, between the fuel crossfeed valve and the engines. The boost pumps are operative and the shutoff valves open, whenever the left hand a-c generator bus is energized and the master engine switches (11, figure 1-4) are at ON.

FUEL BOOST PRESSURE INDICATORS. Fuel boost pressure is displayed in the fuel boost window of each engine performance indicator (25, 26, figure 1-4). The indicator is powered by the 28 volt d-c monitored essential (or in some airplanes the 28-volt d-c essential bus) and has two positions, NORM and OUT. The NORM position indicates that fuel boost pressure is 5 ± 1 psi or above, and the OUT position indicates that pressure is 5 ± 1 psi or below. Refer to ENGINE PERFORMANCE INDICATORS in this section.

FUEL CROSSFEED CONTROL. The crossfeed valve is controlled by the crossfeed switch on the fuel control panel (15, figure 1-4) on the pilot's left-hand console. The switch has two positions, OPEN and CLOSE. Placing the switch at CLOSE closes the crossfeed valve and causes independent fuel boost pressure to be delivered to each engine from its respective fuel boost pump. Placing the switch at OPEN opens the crossfeed valve, permitting both engines to be served by either fuel boost pump in the event of failure of the other.

FUEL DUMPING SYSTEM

The wing tanks fuel dumping system jettisons fuel from the wing tanks if it is desired to reduce the weight of the airplane rapidly. Fuel dumping is effected by means of two wing tanks dump valves and wing tanks pressurization. The system is controlled by the wings fuel dump or purge switch on the fuel control panel (15, figure 1-4) on the pilot's left-hand console. The switch has three positions, DUMP, OFF, and PURGE. The DUMP position of the switch opens the wing tanks dump valves, closes the wing tanks vent valve, closes the forward fuselage tank pressure fueling shutoff valve to prevent wing tanks fuel transfer, and opens the wing tanks air valve to effect pressurization and resultant dumping. The OFF position of the switch is self-explanatory. For a description of the function of the PURGE position of the wings fuel dump or purge switch, refer to WING TANK PURGE SYSTEM in this section.

Note

The DUMP and PURGE positions of the wings fuel dump or purge switch override all functions of the transfer switch, regardless of transfer switch position.

WING TANK PURGE SYSTEM

A wing tanks purging system is installed in the airplane to reduce the possibility of explosion due to anti-aircraft fire penetrating the wing tanks. The purging system is controlled by the wings fuel dump or purge switch of the fuel control panel (15, figure 1-4) on the pilot's left-hand console. Placing the switch at PURGE closes the wing dump valves, closes the wing vent valve, and energizes the wing tanks purge solenoid, releasing CO₂ gas from the CO₂ purge cylinder in the left-hand wheel well into the wing tanks. A complete purge can be assured only if purging is accomplished with completely empty wing tanks at an altitude above 30,000 feet. Below this altitude, purging will be relatively less effective according to the decrease in altitude. If the wing tanks have not been fueled, purging can be initiated immediately after take-off but the effectiveness of purging at low altitude is nearly negligible.

Note

- The DUMP and PURGE positions of the wings fuel dump or purge switch override all functions of the transfer switch, regardless of transfer switch position.
- A red blow-out disc is located in the right-hand wheel well. When ruptured, the disc indicates loss of CO₂ pressure due to blowout from over-temperaturing. This indicator disc is not affected by normal depletion of the CO₂ bottle. It is imperative, therefore, that operation of the purge system be logged in the Naval Aircraft Flight Record form in order that the CO₂ cylinder will be replaced prior to the next flight.

FUEL QUANTITY INDICATING SYSTEM

The fuel quantity indicating system comprises eleven dielectric-type fuel quantity probes, master display unit (fuel quantity and totalizer indicator), fuel quantity selector switch, low level switch, warning light, and associated wiring. The wing tanks contain four fuel quantity probes each; the forward fuselage tank, one; the aft fuselage tank, two. These probes are wired into the fuel quantity indicator in such a manner as to indicate through the use of a selector switch total fuel quantity remaining in a counter-type window, and individual tank quantities on a dial.

CONTINUOUS INDICATING FUEL TOTALIZER.

The fuel quantity indicator (27, figure 1-4), located on the pilot's instrument panel, indicates, in pounds, the quantity of fuel aboard the airplane. A counter-type

Revised 15 September 1960

SERVICING DIAGRAM

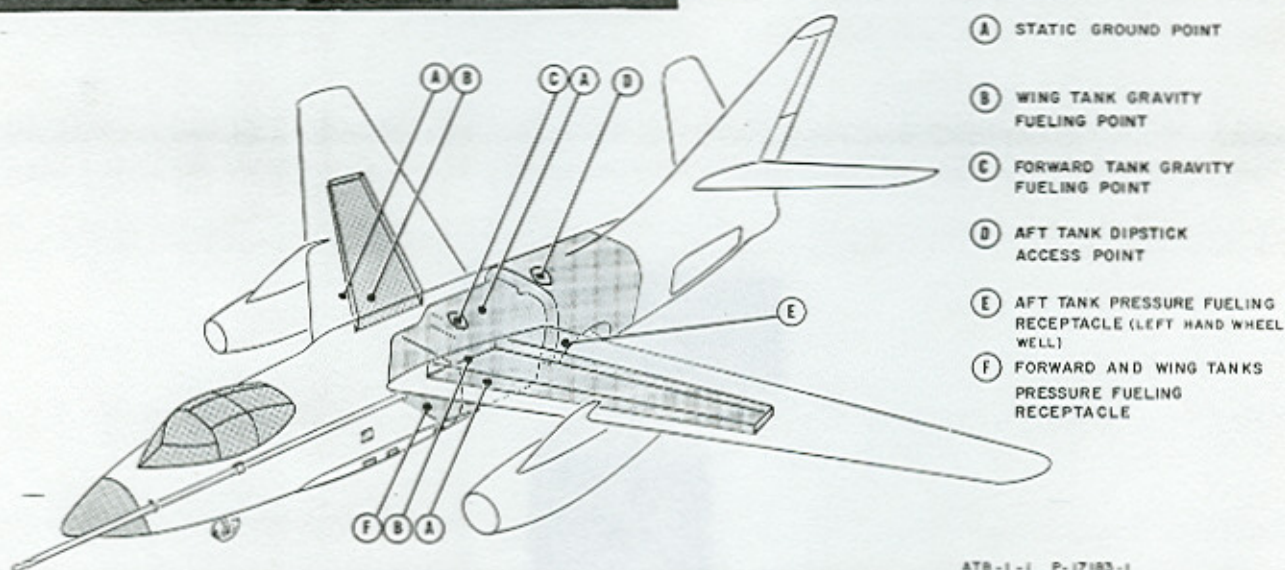

UNIT DESCRIPTION	NORMAL CAPACITY	SPECIFICATION
1. Aft tank pressure fueling receptacle	1300.0 U.S. gallons	JP-4, JP-5, or AVGAS (Emerg. Fuel)
2. Wing and fwd fuselage tank pressure fueling receptacle	3112.0 U.S. gallons	JP-4, JP-5, or AVGAS (Emerg. Fuel)
3. Fwd fuselage tank gravity filler	1832.0 U.S. gallons	JP-4, JP-5, or AVGAS (Emerg. Fuel)
4. Left-hand wing tank gravity filler	667.0 U.S. gallons	JP-4, JP-5, or AVGAS (Emerg. Fuel)
5. Right-hand wing tank gravity filler	667.0 U.S. gallons	JP-4, JP-5, or AVGAS (Emerg. Fuel)
6. Engine oil tank (2)	5.5 U.S. gallons	MIL-L-7808(PWA-521A) oil
7. ATM (2)	2.6 quarts each	MIL-O-6081 oil grade 1010 (160° to -20° C) or MIL-O-6081 oil grade 1005 (-20° to -65° C)
8. Utility hydraulic system reservoir	4.48 gallons	MIL-O-5606 hydraulic fluid
9. Aileron control system hydraulic reservoir	0.32 gallon	MIL-O-5606 hydraulic fluid
10. Surface control system hydraulic reservoir	0.32 gallon	MIL-O-5606 hydraulic fluid
11. Spoiler system accumulator and pressure gage	1150 psi	Compressed air
12. Turret system air bottle and pressure gage	3000 psi	Compressed air
13. Arresting hook accumulator and pressure gage	650-700 psi	Compressed air
14. M. G. brake accumulator hytrol and pressure gage	400 psi	Compressed air
15. Nosewheel steering accumulator and pressure gage	350 psi	Compressed air
16. Landing gear doors air bottle	3000 psi	Compressed air
17. Emergency wing flaps and emergency generator air bottle and gage	3000 psi	Compressed air
18. Emergency landing gear air bottle and gage	3000 psi	Compressed air
19. Emergency wheel brakes air bottle and gage	3000 psi	Compressed air
20. Flash bomb bay doors air bottle and gage	3000 psi	Compressed air
21. Bailout warning horn bottle and pressure gage	2000 psi	Dry nitrogen gas
22. Liquid oxygen converter and filler valve (2)	10 liters each	Liquid oxygen
23. Emergency oxygen bottle and pressure gage	1800 psi	Dry breathing oxygen
24. CO ₂ bottle wing tank purge	1800 psi 15.0 LB CO ₂	Replace unit if blowout disk is ruptured or if the system has been used
25. Canteens (3)	1 quart each	Drinking water
26. Thermos bottles (2)	1 quart each	Hot or cold beverage

Figure 1-18. Servicing Diagram

Revised 15 September 1960

57

MILITARY POWER PRESSURE RATIO

MODEL: A3D-2P, -2Q, -2T

SEA LEVEL

STANDARD DAY

ENGINE: J57-P-10

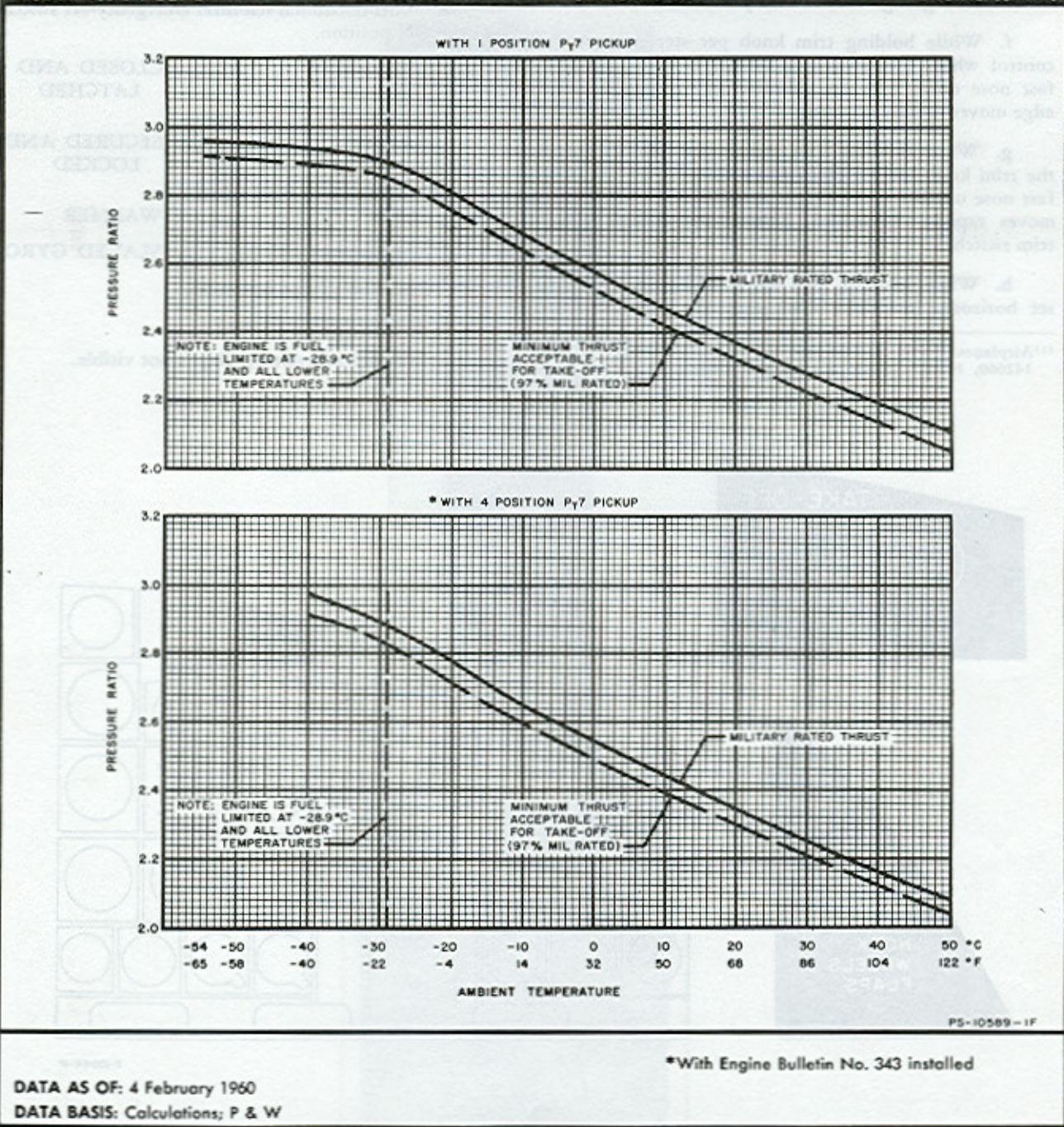

Figure 2-5. Pressure Ratio Chart

Revised 15 September 1960

wise to second detent. Observe fast nose down trim on indicator as stabilizer leading edge moves rapidly upward. Release the control wheel trim switch.

d. Release control trim knob. Note that the knob springs back to neutral position without binding.

e. Rotate console trim knob clockwise to first detent. Observe slow nose up trim on indicator as stabilizer leading edge moves slowly downward.

f. While holding trim knob per step 4e, operate control wheel trim switch to NOSE DOWN. Observe fast nose down trim on indicator as stabilizer leading edge moves rapidly upward.

g. While holding trim switch per step 4f, rotate the trim knob further clockwise to second detent. Note fast nose up trim on indicator as stabilizer leading edge moves rapidly downward. Release the control wheel trim switch.

h. While holding trim knob setting per step 4g, set horizontal stabilizer emergency-off gang-bar⁽¹⁾ on

center console to EMERGENCY OFF. Note that stabilizer trim motion stops.

i. ⁽¹⁾Rotate the trim knob back to the first detent in the nose-up direction. Observe that no trim motion takes place.

j. ⁽¹⁾Release the trim knob. Note that it returns automatically to neutral position without binding.

k. ⁽¹⁾Set horizontal stabilizer emergency-off switches to the ON position.

5. Ditching hatch CLOSED AND LATCHED
6. Shoulder harness and safety belts SECURED AND LOCKED
7. Cockpit temperature selector knob WARMER
8. Compass mode switch SLAVED GYRO
9. Check interphone operation.
10. VGI (attitude indicator):

a. Check that warning flag is not visible.

⁽¹⁾Airplanes BuNo. 144837 and subsequent; 142256, 142666-142669, 144825-144836 after service change.

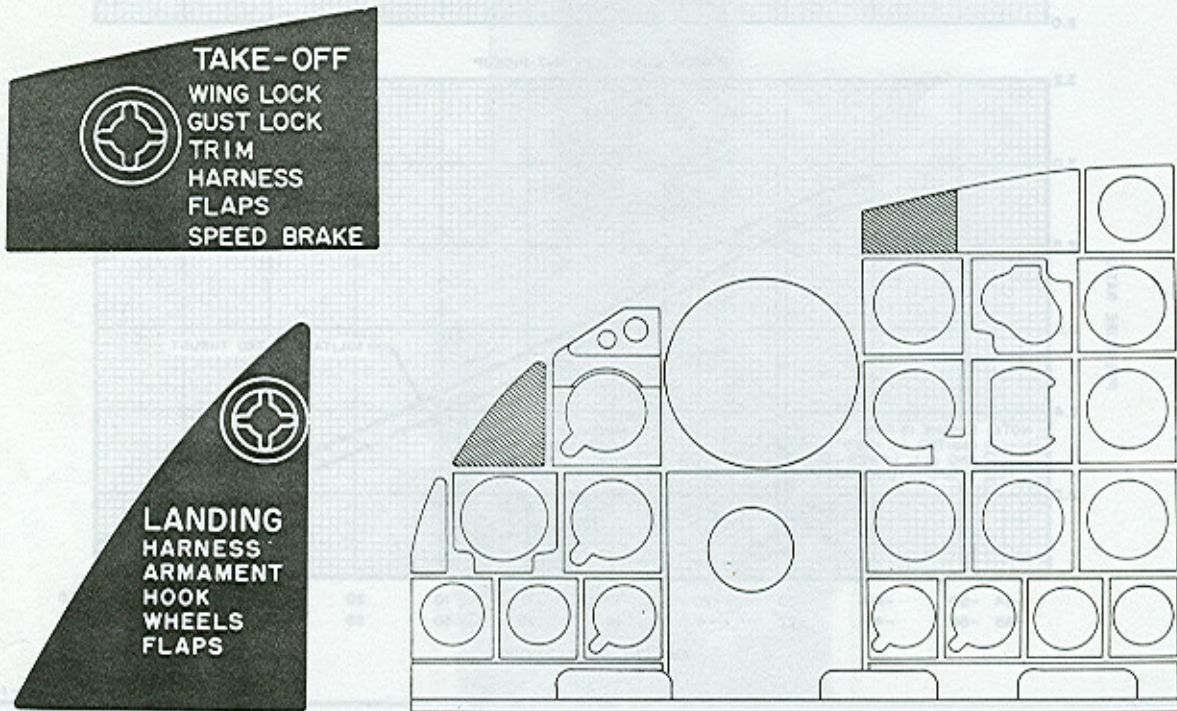

P-10544-1F

Figure 2-6. Pilot's Check Lists

ELEVATOR TRIM VS CG POSITION

CATAPULT TAKE-OFF

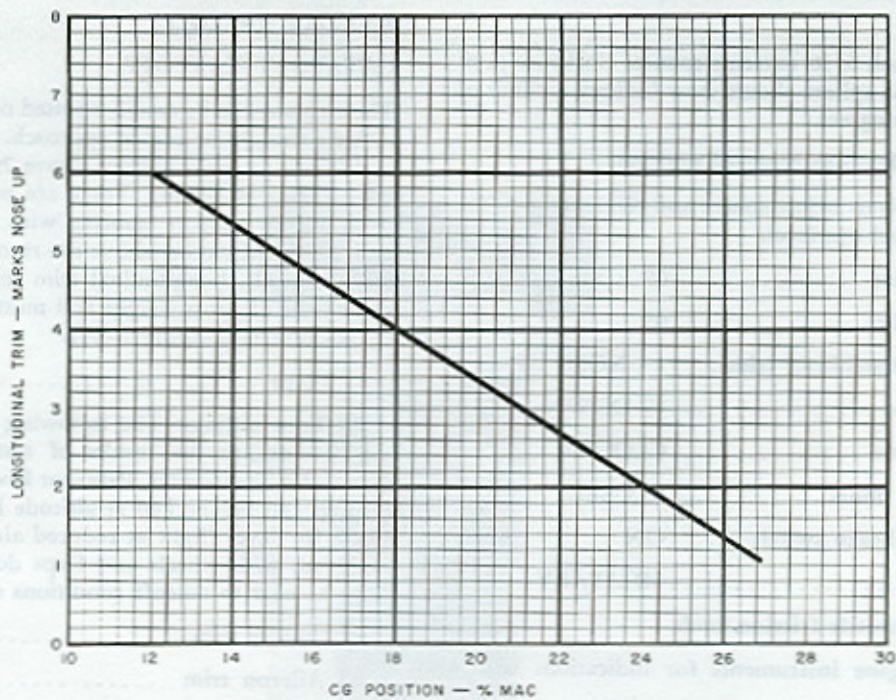

Figure 2-6A. Horizontal Stabilizer vs CG Position

CATAPULT MINIMUM END AIRSPEED VS GROSS WEIGHT

STANDARD DAY

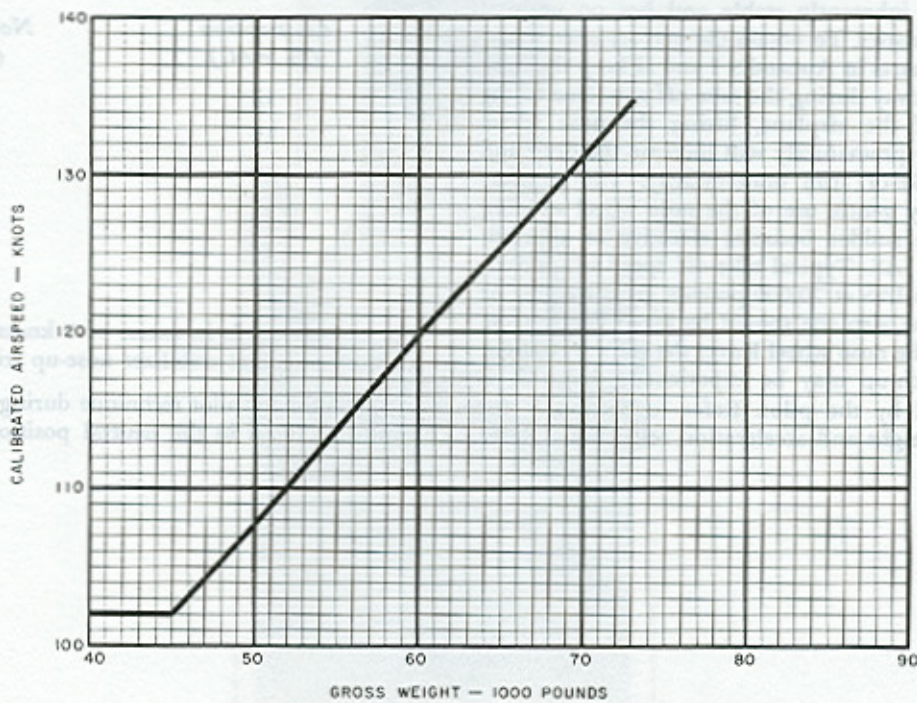

Figure 2-6B. Catapult Minimum End Airspeed vs Gross Weight

Revised 15 September 1960

72A

- b. Turn pitch trim knob from its centered position to the extreme clockwise position. The sphere should move to indicate a dive of 10 to 15 degrees.
- c. Turn knob to its extreme counter clockwise position. The sphere should now indicate a climb of 5 to 10 degrees.
- d. Return knob to centered position.
- e. Use knob to adjust sphere and reference airplane for proper eye level.

- 11. Rudder trim 0°
- 12. Aileron trim 0°
- 13. Horizontal stabilizer trim 2° NOSE UP
- 14. Wing flaps ½ DOWN
- 15. Speed brakes CLOSED
- 16. Bomb bay doors CLOSED
- 17. Anti-skid brake switch ON
- 18. Throttles MILITARY
- 19. Tighten throttle friction knob.
- 20. Check engine instruments for indications within limitations.
- 21. Release brakes and begin take-off run.

TAKE-OFF

The airplane is inherently stable and has no unusual take-off characteristics. To obtain the performance stated in the take-off charts in Appendix I and II keep the nose wheel on the runway during the take-off run. Due to the configuration of the airplane, lifting the nose wheel from the runway prematurely will increase the drag and lengthen the take-off run unnecessarily. The airplane can be steered by gentle use of the nose wheel steering system until the rudder becomes effective at approximately 60 knots IAS. Typical take-off speed is approximately 165 knots IAS at 70,000 pounds gross weight. At take-off speed the airplane should be lifted gently from the ground. As the nose wheel leaves the runway, a slight longitudinal pitch-up may be experienced, but this is easily controlled by the pilot. Refer to Section V for take-off gross weight and acceleration restrictions. Refer

to Section III for procedures to be employed in the event of a take-off emergency.

ASSISTED TAKEOFF

CATAPULT TAKEOFF

The airplane can be readily spotted on the catapult, using either a straight or angled approach. Nose wheel steering is difficult at gross weights above 70,000 pounds unless the airplane is moving. There are no unusual characteristics during catapult launches with normal cg positions and at 10 to 15 knots above the recommended minimum end airspeeds. Longitudinal trim setting is virtually independent of gross weight and must be set according to cg position (see figure 2-6A).

- 1. Flaps FULL DOWN

2. Trim settings: The following trim setting recommendations are the results of tests conducted at the Naval Air Test Center, Patuxent River, Maryland. These settings can be checked at altitude by trimming the airplane for level flight at reduced airspeed at the weight involved, with wheels and flaps down, and power settings as near to takeoff conditions as practicable:

- a. Rudder trim 0°
- b. Aileron trim 0°

c. Horizontal stabilizer trim: The horizontal stabilizer trim settings depend upon the airplane cg position. The following horizontal stabilizer trim settings are mandatory for all launches from 0 to 7 knots above minimum end airspeeds.

CG Position (% MAC)	Nose-up Trim (Marks)
12	6
15	5
18	4
21	3
24	2
27	1

For end airspeeds in excess of 7 knots above minimum, reduce horizontal stabilizer nose-up trim as required.

3. Optimum pilot technique during launch: Hold the control column in the neutral position throughout the



Figure 2-6A. Catapult Minimum End Airspeed vs Gross Weight

catapult launch, except for launches at or near minimum end airspeeds with the cg at or near the recommended forward limit. During launches at or near minimum end airspeeds (see figure 2-6B), and with the cg at or near the recommended forward limit, sink off the bow may be encountered that will require slight back pressure on the control column. Delay the clearing turn until positively past the bow.

In basic-wing airplanes, mild to moderate pre-stall buffet will be encountered at end airspeeds within 5 knots of the recommended minimum at 70,000 pounds gross weight; or within 10 knots at 73,000 pounds. Extreme forward cg positions or over-rotation will increase buffet intensity. The landing gear should be retracted immediately. Any mild wing drop should be counteracted with rudder rather than aileron. Delay the clearing turn until airspeed is well above launching airspeed.

4. Throttles MILITARY

Hold throttles forward with heel of hand, simultaneously grasping handgrip with fingers.

5. Headrest: The headrest should be used when catapulting. An uncomfortable neck jerk, possibly producing temporary loss of control, will result if the head is not held firmly against the headrest during the launching run.

For signaling during night catapult operations, all exterior lights are controlled by an exterior lights master switch, located on the right-hand throttle. The desired exterior lighting should be selected on the exterior lights panel prior to launch.

Note

Refer to A3D aircraft launching bulletins for additional information.

WARNING

Do not perform catapult takeoffs with partial wing fuel. Unpredictable cg position and movement can result in a severe airplane pitchup after launch.

JATO TAKEOFF

The use of JATO is restricted to airfield takeoffs. Present calculations indicate that the most effective use of JATO will be during the last five seconds of the takeoff run. Flight characteristics during JATO operations, including lift-off and burnout, are satisfactory. Refer to Appendix I and II for JATO firing speeds. For detailed information concerning JATO takeoff procedures, refer to the paragraph entitled TAKEOFF DISTANCE MINIMUM GROUND ROLL—12 UNITS JATO, Appendix I and II.

Revised 15 September 1961

AFTER TAKE-OFF

1. Retract the landing gear as soon as the point is reached beyond which a safe landing cannot be made. Landing gear retraction time is a maximum of 12 seconds.

CAUTION

Do not exceed maximum gear-down airspeed.

2. JATO switch, if applicable ... JETTISON
3. Flaps lever UP
4. Trim the airplane.
5. Check engine instruments.
6. Cockpit temperature selector knob AS DESIRED

JATO JETTISONING

Jettisoning of JATO bottles should be accomplished in level flight, as soon as practicable, with flaps down, and with airspeed below 200 KIAS. JATO bottles can be carried safely up to 300 KIAS. Jettisoning causes a slight nose-down pitch.

CLIMB

The airplane should be accelerated to climbing speed as soon as practicable after takeoff to obtain maximum performance. Using military power, initiate climb at approximately 360 KIAS at sea level. Use a lower IAS in turbulent air. Military power should be used during the climb. If less than military power is used, the excessive time required to reach a given altitude will result in a reduction in range. Refer to Appendix I and II CLIMB CHARTS, for climb performance under various operating conditions. Transfer wing tank fuel when the forward fuselage tank has been depleted to a low level.

CRUISE AFTER CLIMB

SINGLE-ENGINE CRUISE. Whenever it is required for increased endurance or for practice, single-engine operation should be conducted with the left-hand engine secured. With the right-hand engine secured, fuel does not flow through the hydraulic oil cooler. Following each flight with the right-hand engine secured due to mechanical trouble, the hydraulic pumps must be inspected for damage.

FLIGHT CHARACTERISTICS

Refer to Section VI for information concerning the flight characteristics of the airplane.

TYPICAL TAKEOFF PATTERN

NOTE

THE TAKEOFF AIRSPEED GIVEN HERE IS FOR 70,000 POUNDS GROSS WEIGHT AND FULL FLAPS. REFER TO THE APPENDIX FOR TAKEOFF AIRSPEEDS AT OTHER GROSS WEIGHTS AND FOR CLIMB PERFORMANCE DATA.

RETRACT FLAPS AFTER GEAR IS UP AND WHILE ACCELERATING TO CLIMBOUT SPEED

ON BECOMING AIRBORNE, A SLIGHT FORWARD-STICK PRESSURE WILL BE REQUIRED TO MAINTAIN THE DESIRED NOSE ATTITUDE

EASE NOSE OFF SLIGHTLY AS FLYING SPEED IS OBTAINED (APPROXIMATELY (1) 140 KIAS (2) 130 KIAS)

START CLIMBOUT AT (1) 375 KIAS (2) 380 KIAS AT SEA LEVEL

GEAR UP

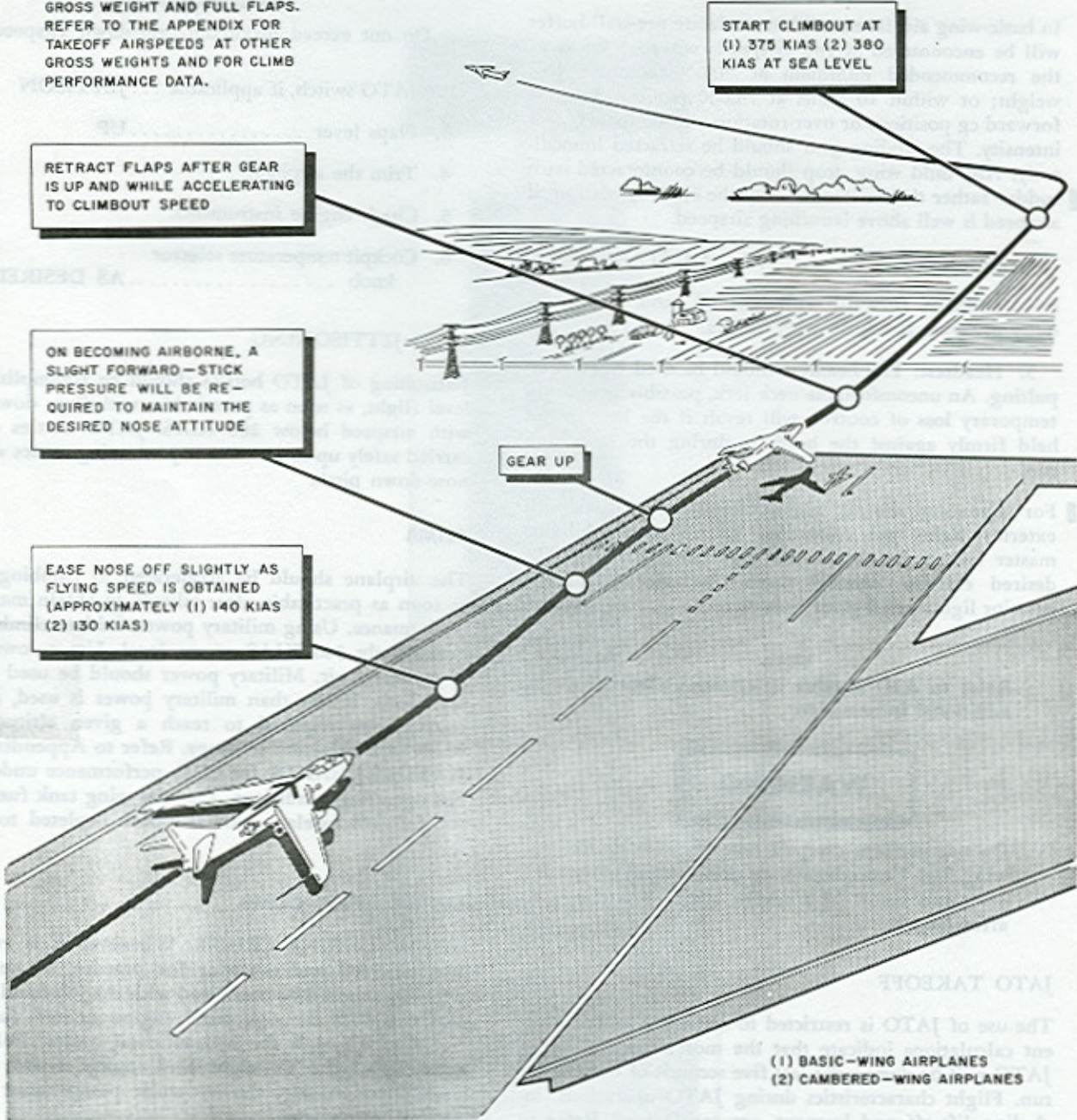

- (1) BASIC-WING AIRPLANES
- (2) CAMBERED-WING AIRPLANES

ATB-1-2 P-17151-1A

Figure 2-7. Takeoff Pattern (Typical)

DESCENT

Normal techniques may be used to attain the desired rate of descent. Prior to descent, close camera window doors at lower (200-300K) airspeeds, if possible, since the effort required (manual crank) increases with indicated airspeed. Cage all camera mount functions, and pull stabilization signal circuit breakers on circuit breaker and fuse panel NO. 106. Refer to Appendix for maximum range descent performance data. Maximum rate descent may be obtained by using idle rpm, opening the speed brakes, and diving at maximum allowable airspeeds as outlined in Section V, Operating Limitations. Refer to Section VI, Flight Characteristics, for precautions to be observed during diving and high speed flight.

PRE-TRAFFIC PATTERN CHECK LIST

1. Check fuel quantity.
2. Check brake pressure gage ... 3000 PSI
3. Speed brakes AS DESIRED
4. Safety belts and shoulder harnesses TIGHTENED AND LOCKED

TRAFFIC PATTERN CHECK LIST

Refer to Section V for landing gross weight and C.G. limitations.

1. Illuminant system ready switch SAFE
2. Master camera power switch .. OFF
3. Arresting hook control HOOK UP OR DOWN, AS REQUIRED
4. Speed brakes switch OPEN
5. Landing gear handle DOWN

Note

Do not exceed landing gear extension airspeed limitations.

6. Wing flaps lever DOWN
7. Re-trim airplane as required.

LANDING

It is advisable to maintain as high an engine rpm as is compatible with approach conditions in order to reduce the time delay for engine acceleration, should a wave-off or go-around become necessary. Refer to Appendix I and II, LANDING CHART, for recommended approach airspeeds at various gross weights. Refer to Section III for information concerning landing emergencies.

Revised 15 September 1960

AIRFIELD

The landing characteristics of the airplane are normal. Never permit the airplane to stall in. After touchdown, move the throttles to IDLE and ease the nose wheel down. The wing flaps should be raised immediately after touchdown. The drag chute may be "deployed" in accordance with squadron policy. Directional control can be maintained by use of rudder down to approximately 60 knots IAS, at which time nosewheel steering must be used.

CAUTION

- Do not touch the nose wheel steering control at touchdown. The steering control must be free to swivel as the nose wheel casters to prevent damage to the nose gear scissors linkage.
- The nose wheel steering is extremely sensitive at high speeds. Make directional changes with rudder until speed drops below 60 knots.

CARRIER**CAUTION**

The Hytrol system anti-skid switch should be turned OFF during carrier operations.

MIRROR LANDING APPROACH. The down-wind leg is flown at an altitude of 600 feet above the carrier deck at approximately 135 knots IAS. A level turn of approximately 15 degrees to 17 degrees angle of bank is begun at the ramp. This turn is varied in order to intercept the optical glide path at 600 feet altitude and at a distance of approximately 7000 feet astern of the carrier. On interception of the glide path, the speed brakes are opened and a rate of descent is set up. The airplane is flown down the glide path at an approach speed of approximately 122 to 128 knots IAS. The "no-flare" landing technique is used.

LSO APPROACH. In the LSO approach, the carrier landing pattern and the glide path are identical to the pattern and glide path flown when using the mirror approach system. After the "release" (cut) signal is given by the LSO, the pilot flies the airplane to the deck exactly as when using the mirror system.

CAUTION

- Carrier landings on angled deck ships should be made with particular attention to achieving a good line-up and avoiding landings with right to left drift which, when associated with the increased runout of angled deck arresting gear, can result in the airplane coming to rest in the port catwalk even though a pendant is engaged.

TYPICAL LANDING AND WAVE-OFF PATTERN

NOTE

THE AIRSPEEDS GIVEN HERE APPLY TO A GROSS WEIGHT OF 50,000 POUNDS IN POWER APPROACH CONFIGURATION. ADD 1 KNOT FOR EACH 1,000 POUND INCREASE IN GROSS WEIGHT.

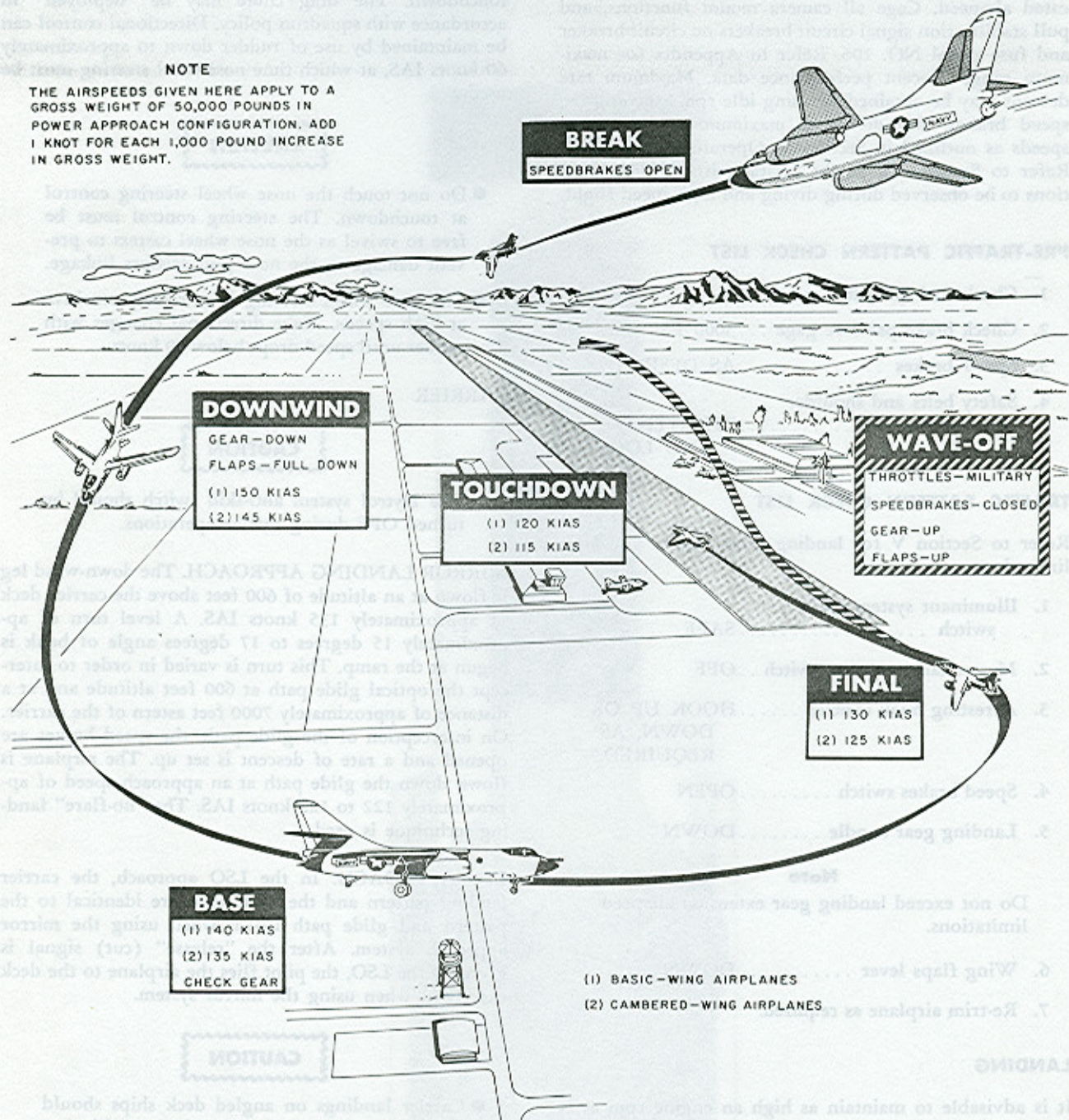

ATB-1-2 P-11154-11

Figure 2-8. Landing and Wave-Off Pattern (Typical)

- A burble effect, present under all wind conditions, produces a definite tendency for the right wing to drop as the airplane approaches and passes the round-down at the forward end of the landing area on angled deck ships.

HEAVY WEIGHT

Approach and landing with the airplane heavily loaded must be made at proportionately higher airspeeds. Refer to the gross weight limitations for landing listed in Section V. Consumption or jettisoning of surplus fuel is necessary if the airplane exceeds these gross weights.

CROSS WIND

For cross-wind landing it is recommended that the "up-wind wing low" method be employed. A slightly higher approach and landing speed than recommended for normal landing should be used. It is not necessary to pick up the low wing prior to touchdown if not over 10 degrees of bank angle is used, since the airplane will right itself on contact with the runway. However, care should be taken not to "drop the airplane in," else the up-wind landing gear oleo will rock the airplane to the opposite landing gear.

CAUTION

Do not exceed 10 degrees of bank angle, else the low wing tip may drag on the runway upon initial landing impact.

Just prior to touchdown the airplane axis should be aligned with the runway and the wings leveled to within 10 degrees or less by use of the rudder. Because of the strong rolling response of the airplane to rudder application at low speeds, care should be taken to prevent over-controlling laterally.

Immediately after touchdown, deploy the drag chute. A secondary aid in high winds is to retract flaps as soon as possible after deploying the drag chute. Deploying the drag chute will minimize the time the airplane is exposed to the cross-wind, and add a corrective component for the airplane's tendency to turn down wind. Lead with aileron control to keep the up-wind wing level or slightly low. Some lateral control is available through use of the ailerons above 60 knots IAS.

The airplane can be controlled in 90-degree cross winds up to 15 knots. With higher cross-wind velocities or with gusts, the controllability of the airplane is marginal. The relatively narrow tread and small clearance between the wing tips and the ground combine to increase the probability of dragging a wing tip.

MINIMUM RUN

For minimum run landings, utilize the approach speed shown in the LANDING CHART, Appendix I and II.

As soon as the airplane is on the ground, retard the throttles to IDLE, place the nose wheel on the runway, raise the flaps, and smoothly apply maximum braking effort. Use normal braking pedal force, at speeds under 50 knots. Refer to ANTI-SKID BRAKE SYSTEM in Section I.

MINIMUM RUN WITH DRAG CHUTE

Flight tests indicate that deployment of the drag chute can be safely accomplished immediately after main gear touchdown. Observe the recommended approach and landing technique for minimum run and place the drag chute switch at DEPLOY as soon as both main gear wheels are firmly on the runway. Deployment of the chute will require 3 seconds at the maximum and air-speed should be approximately 120 knots as drag chute deceleration takes effect.

CAUTION

Do not deploy drag chute at airspeed in excess of 170 knots IAS. The equipment is automatically jettisoned through failing of a shear pin at 175 knots IAS.

GO-AROUND OR WAVE-OFF

1. Throttles MILITARY
2. Speed brakes switch CLOSE
3. Landing gear handle UP
4. Flaps lever UP

Note

The flaps require approximately 25 seconds to retract from the full down position.

AFTER LANDING

1. Speed brakes switch CLOSE
2. Flaps lever UP

Following minimum run landing with drag chute, proceed as follows at pilot discretion:

3. Drag chute switch JETTISON-STOWED

CAUTION

- It is recommended that the drag chute not be jettisoned above 40 knots IAS. If the drag chute has not been jettisoned prior to stopping the airplane, it is advisable to postpone jettisoning of the chute until engine shutdown to prevent damage to the canopy.
- Excessive heat build-up from prolonged braking may increase tire pressure and decrease the strength of the wheels and tires enough to cause explosive failure.

POST FLIGHT ENGINE CHECK

Prior to stopping the engines, check all instruments for proper indications. Refer any discrepancies noted to the proper personnel, and enter such discrepancies on the proper forms.

BEFORE STOPPING THE ENGINES

1. Cockpit temperature selector knob OFF
2. Anti-icing switch OFF
3. Wing and fin fold lever AS DESIRED
4. Gravity transfer switch NORMAL
5. Wings fuel dump or purge switch OFF

STOPPING THE ENGINES**CAUTION**

Allow the engine to idle for five minutes if it has been operated at 85% RPM or higher for one minute during the previous five minutes.

1. Advance the throttle to 75% RPM for approximately 2 seconds, then:
2. Throttles OFF
3. Master engine switches (within 2 seconds after moving throttles to OFF) OFF
4. Check that the engines decelerate freely and without any metallic rubbing sounds.

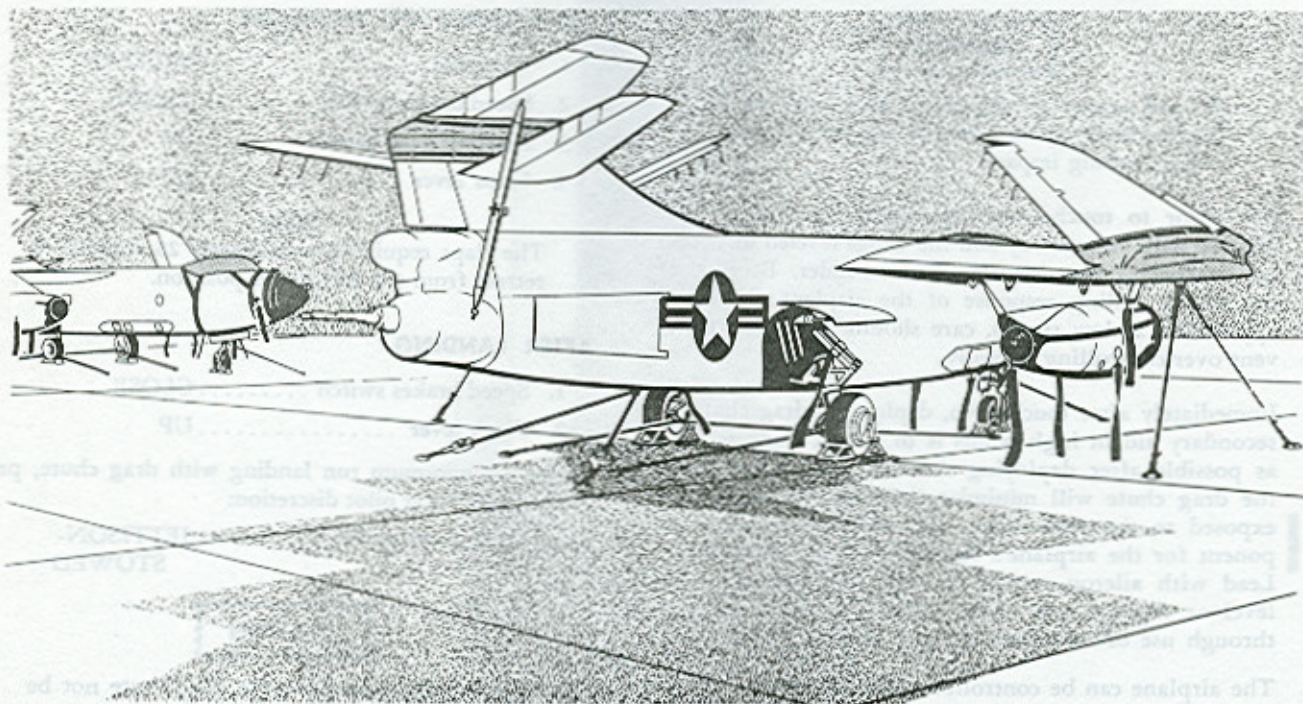

ATB-1-2 P-11209-1E

Figure 2-9. Mooring

BEFORE LEAVING THE AIRPLANE

1. ATM switches OFF
2. BUS TIE switch OPEN
3. A-c generator switches OFF
4. D-c generator switches OFF
5. All radio and radar gear SECURED
6. Engage gust locks.
7. Chock wheels.

If gusty wind conditions exist or are anticipated, moor the airplane securely. Install engine exhaust covers, inlet duct covers, and compressor bleed port plugs. Close bomb bay doors, install landing gear locking pins, fin jury strut, and covers for cockpit enclosure, and for folded fin and folded wing butts.

If the airplane is to be secured for the day or for any extended period, actuate the horizontal stabilizer to the

full nose-up trim position. This will retract the horizontal stabilizer actuator jackscrew, thereby lessening its possibility of corrosion.

Note

This procedure is not recommended for routine post-flight shut-down, because excessive ground operation may reduce the service life of the actuator motor, and because the procedure increases the risk of the next pilot's trying to take off with full nose-up trim.

TOWING PROCEDURE

To tow the airplane, first disconnect the nose wheel torque link. After this has been done the airplane can be towed forward or backward by a tow bar attached to the nose wheel axle. Maintain a minimum of 1500 psi on the brake system pressure gage by operation of the deck handling hydraulic hand pump.

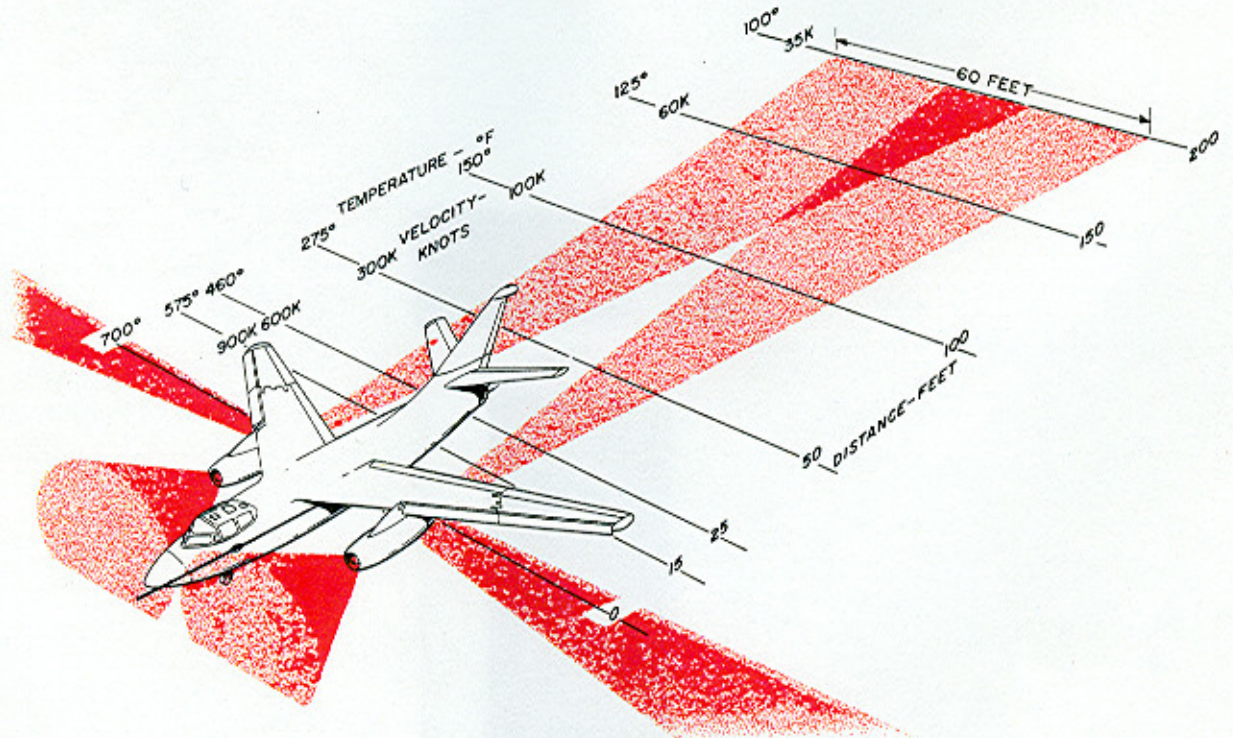

MILITARY POWER

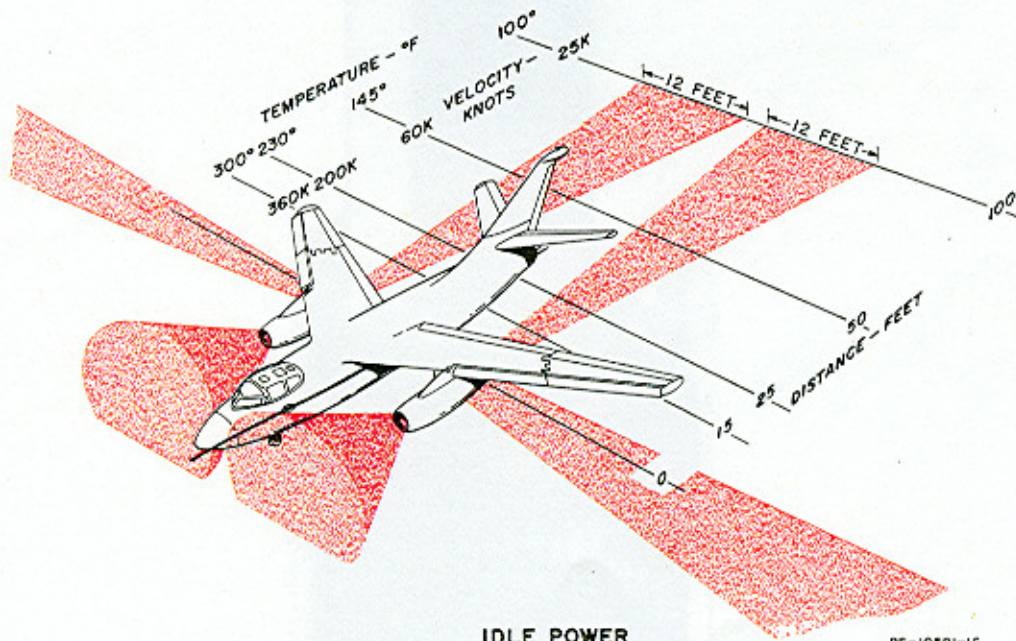



IDLE POWER

PS-10591-1C

Figure 2-2. Danger Areas (Sheet 1)

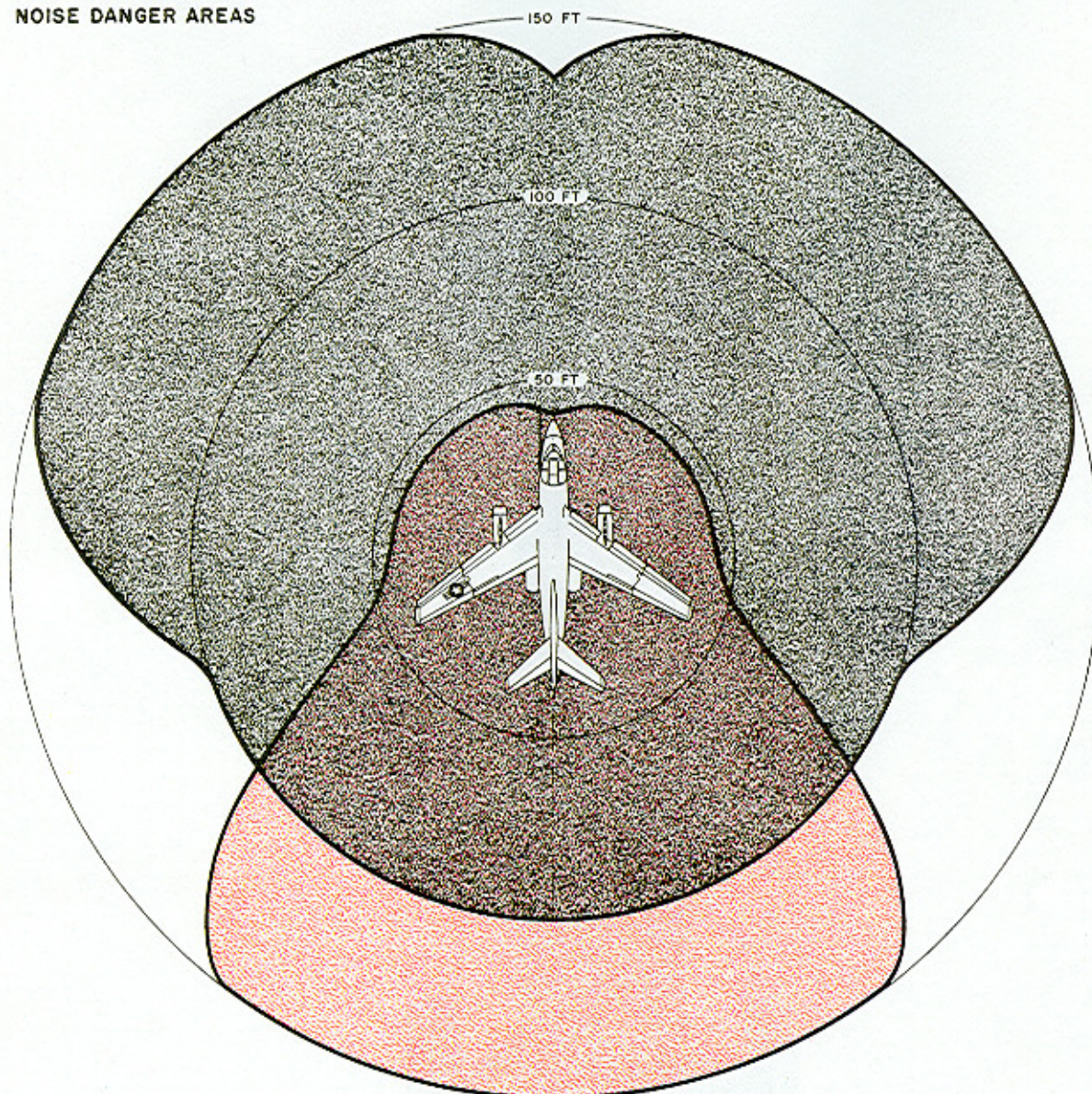
NOISE DANGER AREAS



-  **MILITARY POWER DANGER AREA—DO NOT ENTER**
(THE SOUND PRESSURE LEVEL IS HIGH ENOUGH TO CAUSE HEARING DAMAGE).
-  **IDLE POWER CAUTION AREA—SAFE TO ENTER BRIEFLY WITHOUT EAR PROTECTION; HOWEVER IF IN THIS AREA FOR ANY LENGTH OF TIME, EARPLUGS OR EARMUFFS MUST BE WORN.**

PS-10591-2

Figure 2-2. Danger Areas (Sheet 2)

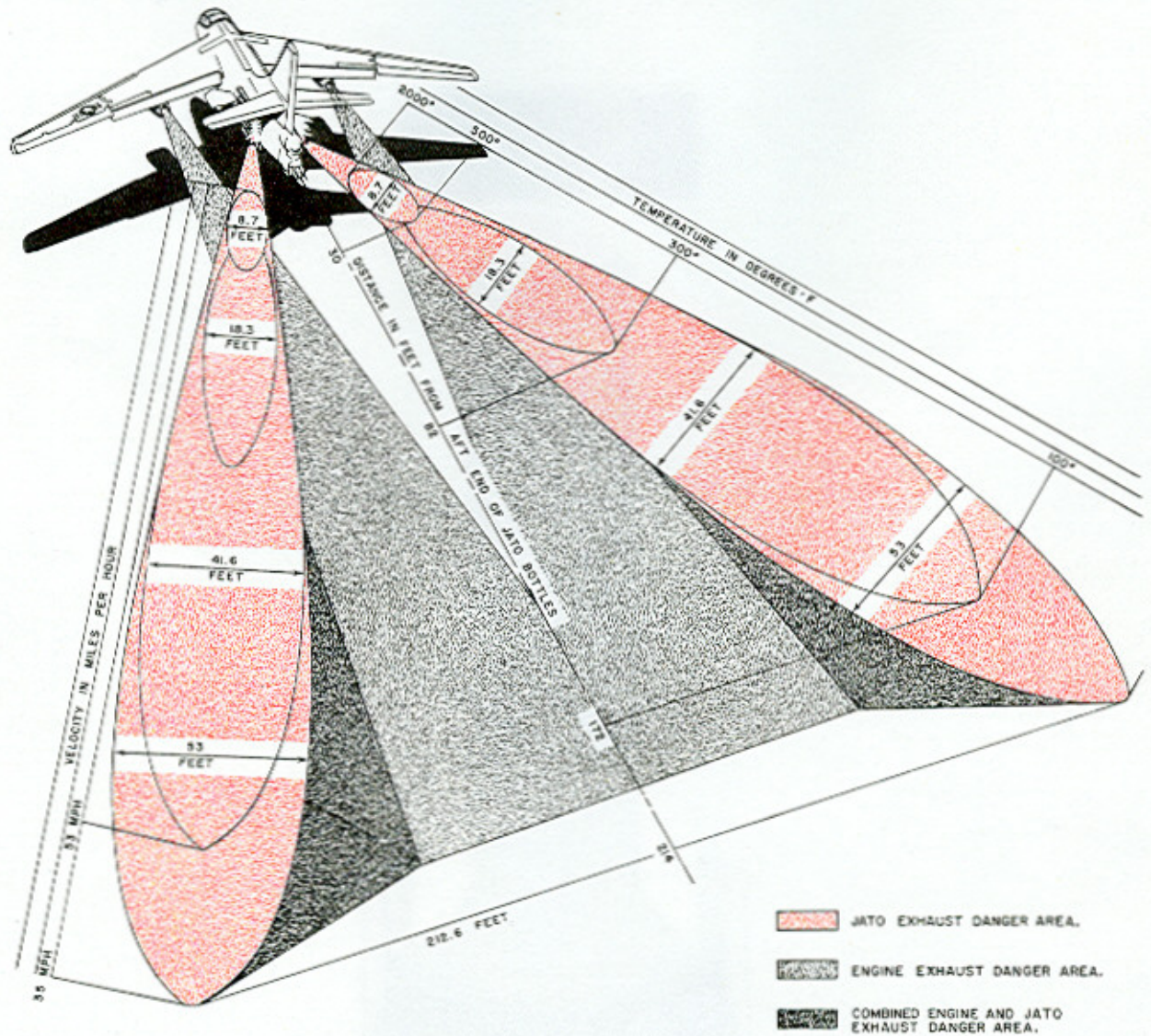

ATB-1-2 PS-10591-3

Figure 2-2. Danger Areas (Sheet 3)

Revised 15 June 1961